

GOUJONS À VISSER DU 328

HETTICH

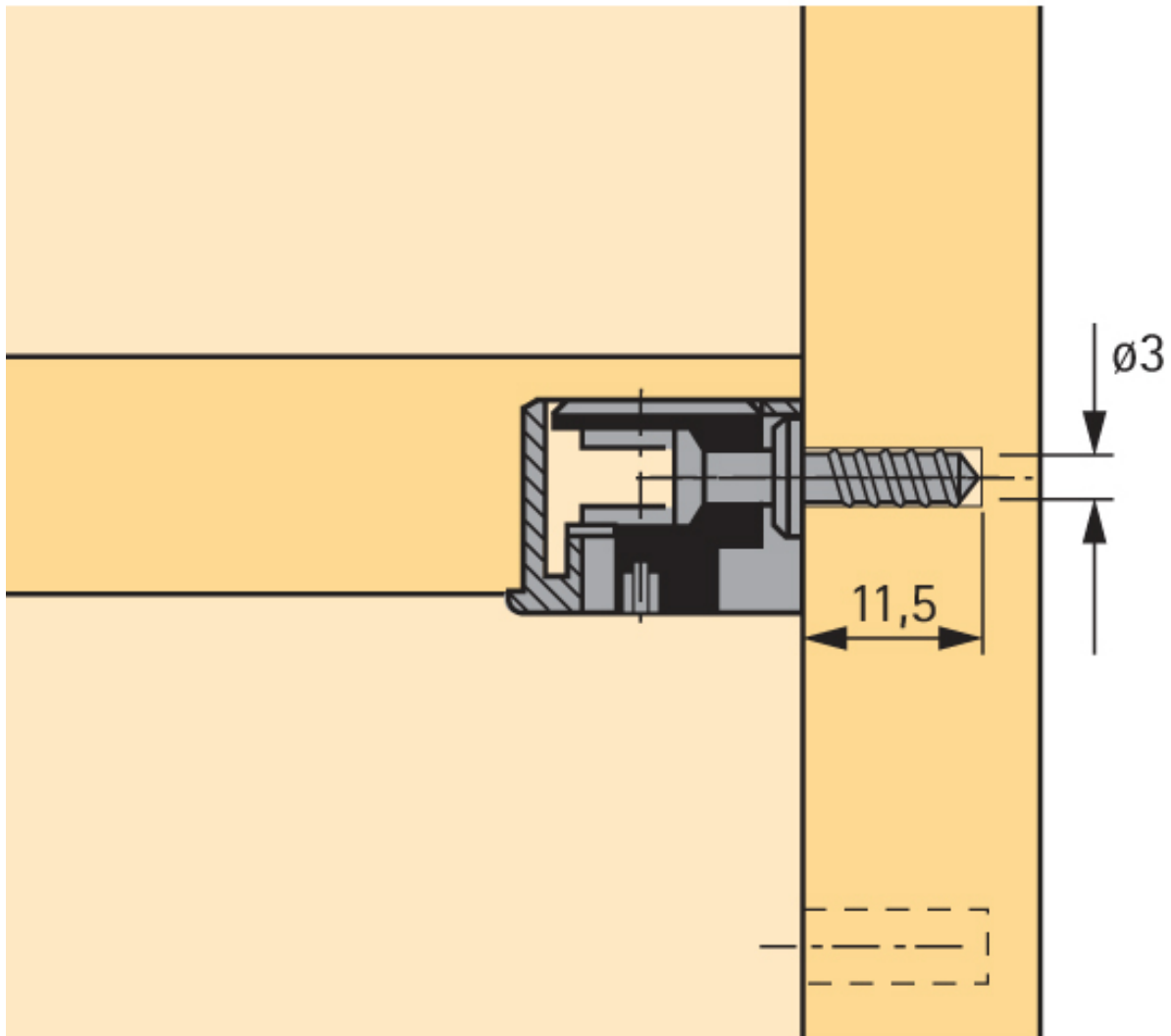

<https://www.quincabox.fr/goujons-a-visser-du-261-p21684>



Tel : 02 43 30 41 38

Fax : 02 43 30 26 16

www.quincabox.fr

GOUJONS À VISSER DU 328

HETTICH

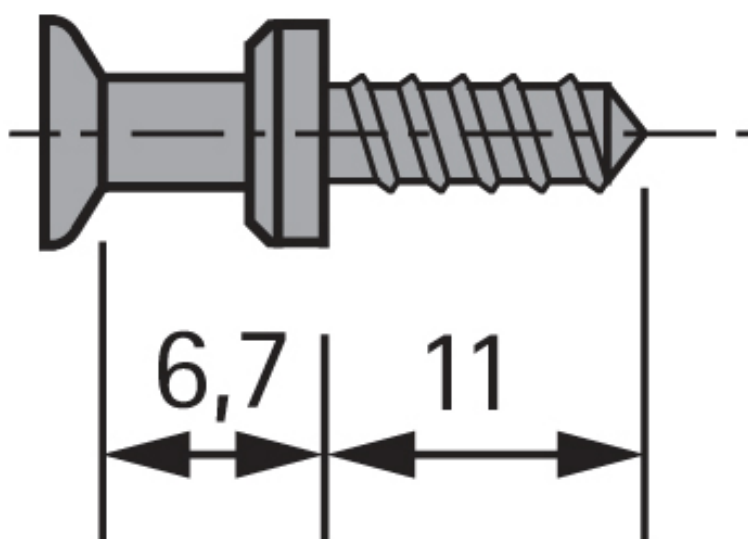

<https://www.quincabox.fr/goujons-a-visser-du-261-p21684>



Tel : 02 43 30 41 38

Fax : 02 43 30 26 16

www.quincabox.fr