

KIT ARSITECH 94 AVEC BANDEAUX HAUTEUR 282

HETTICH

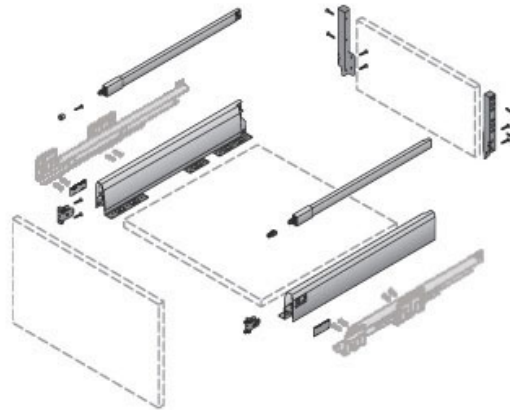

<https://www.quincabox.fr/kit-arcitech-94-avec-bandeaux-hauteur-282-p31239>



Tel : 02 43 30 41 38

Fax : 02 43 30 26 16

www.quincabox.fr